

Super MK Relays.



Models with Latching Lever Added to the Series.

- Same mounting and internal wiring as the previous Super MK Relays
- Built-in mechanical indicator enables checking contact operation.
- Two modes can be used to check circuits for models with latching lever.
- Nameplate provided on models with latching lever.
- All materials are RoHS compliant.
- UL and IEC (TÜV) certification.



Features

Models with Latching Lever

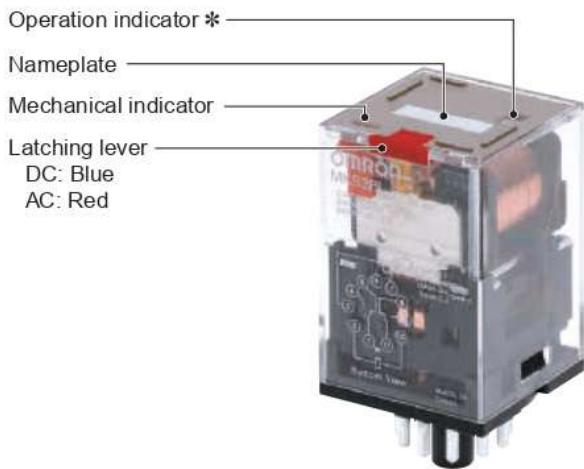

* The operation indicator is built in only on specified models.

Example of Applications of Models with Latching Levers

Operation checks in relay sequence circuits

Operating Method for Latching Lever

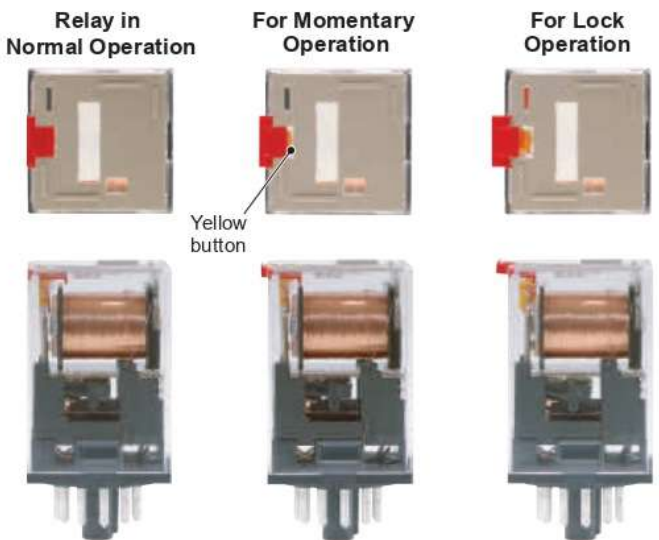

Slide the latching lever to the first position, then press the yellow button with an insulated tool to operate the contact.

Slide the latching lever to the second position. (The contact is now in the locked position.)

Model Number Structure

Model Number Legend

MKS□□□□□-□-□
1 2 3 4 5 6 7

1. Contact Form

- 2: DPDT
- 3: 3PDT

2. Terminals

P: Plug-in

3. Mechanical Indicator/Test Button

- Blank: Mechanical indicator
- I: Mechanical indicator and lockable test button

4. LED Indicator

- Blank: Standard
- N: LED indicator

5. Coil Polarity

- Blank: Standard
- 1: Reverse polarity (DC coil only)

6. Surge Absorption

- Blank: Standard
- D: Surge absorber diode (DC coil only)
- V: Surge absorber varistor (AC coil only)

7. Internal Connections

- Blank: Standard
- 2 or 5: Non-standard connections (Refer to "Terminal Arrangement and Internal Connection (Bottom View)".)

8. Rated Voltage

(Refer to "Coil Ratings".)

Specifications

Ratings

Coil Ratings

| Rated voltage | Rated current | | Coil resistance | Must operate voltage | Must release voltage | Max. voltage | Power consumption | |
|---------------|---------------|---------|-----------------|-----------------------------|--|-----------------------|--|---------|
| | 50 Hz | 60 Hz | | Percentage of rated voltage | | | | |
| AC | 6 V | 443 mA | 385 mA | 80% max. of rated voltage | 30% min. of rated voltage at 60 Hz 25% min. of rated voltage at 50 Hz | 110% of rated voltage | Approx. 2.3 VA at 60 Hz Approx. 2.7 VA at 50 Hz | |
| | 12 V | 221 mA | 193 mA | | | | | |
| | 24 V | 110 mA | 96.3 mA | | | | | |
| | 100 V | 26.6 mA | 23.1 mA | | | | | |
| | 110 V | 24.2 mA | 21.0 mA | | | | | |
| | 200 V | 13.3 mA | 11.6 mA | | | | | |
| | 220 V | 12.1 mA | 10.5 mA | | | | | |
| | 230 V | 10.0 mA | 11.5 mA | | | | | |
| DC | 240 V | 11.0 mA | 9.6 mA | 80% max. of rated voltage | 15% min. of rated voltage | 110% of rated voltage | Approx. 1.4 W | |
| | 6 V | 224 mA | | | | | | 26.7 Ω |
| | 12 V | 112 mA | | | | | | 107 Ω |
| | 24 V | 55.8 mA | | | | | | 430 Ω |
| | 48 V | 28.1 mA | | | | | | 1,710 Ω |
| | 100 V | 13.5 mA | | | | | | 7,390 Ω |
| | 110 V | 12.3 mA | | | | | | 8,960 Ω |

Note: 1. The rated current and coil resistance are measured at a coil temperature of 23°C with tolerances of +15%/–20% for AC rated current and ±15% for DC coil resistance.

2. Performance characteristic data are measured at a coil temperature of 23°C.

3. The maximum voltage is one that is applicable instantaneously to the Relay coil at 23°C and not continuously.

4. For DC-operated Relays with the LED indicator built-in, add an LED current of approx. 5 mA to the rated current.

Contact Ratings

| Load | | Resistive load ($\cos\phi = 1$) | Inductive load ($\cos\phi = 0.4$) |
|------------------------|----|--------------------------------------|--|
| Contact mechanism | | Single | |
| Contact material | | AgSnIn | |
| Rated load | NO | 10 A, 250 VAC 10A, 30 VDC | 7 A, 250 VAC |
| | NC | 5 A, 250 VAC 5 A, 30 VDC | |
| Rated carry current | | 10 A | |
| Max. switching voltage | | 250 VAC, 250 VDC | |
| Max. switching current | | 10 A | |
| Max. switching power | NO | 2,500 VA/300 W | |
| | NC | 1,250 VA/150 W | |

Characteristics

| | |
|---|---|
| Contact resistance | 100 mΩ max. |
| Operate time | AC: 20 ms max. DC: 30 ms max. |
| Release time | 20 ms max. (40 ms max. for built-in Diode Relays) |
| Max. operating frequency | Mechanical: 18,000 operations/h Electrical: 1,800 operations/h (under rated load) |
| Insulation resistance | 100 MΩ min. (at 500 VDC) |
| Dielectric strength | 2,500 VAC 50/60 Hz for 1 min between coil and contacts 1,000 VAC 50/60 Hz for 1 min between contacts of same polarity and terminals of the same polarity 2,500 VAC 50/60 Hz for 1 min between current-carrying parts, non-current-carrying parts, and opposite polarity |
| Insulation method | Basic insulation |
| Impulse withstand voltage | 4.5 kV between coil and contacts (with $1.2 \times 50 \mu\text{s}$ impulse wave) 3.0 kV between contacts of different polarity (with $1.2 \times 50 \mu\text{s}$ impulse wave) |
| Pollution degree | 3 |
| Rated insulation voltage | 250 V |
| Vibration resistance | Destruction: 10 to 55 to 10 Hz, 0.75-mm single amplitude (1.5-mm double amplitude) Malfunction: 10 to 55 to 10 Hz, 0.5-mm single amplitude (1.0-mm double amplitude) |
| Shock resistance | Destruction: 1,000 m/s ² (approx. 100 G) Malfunction: 100 m/s ² (approx. 10 G) |
| Endurance | Mechanical: 5,000,000 operations min. (at 18,000 operations/h under rated load) Electrical: 100,000 operations h. (at 1,800 operations/h under rated load) |
| Failure rate P level (reference value) | 10 mA at 1 VDC |
| Ambient temperature | Operating: -40 to 60°C (with no icing or condensation) |
| Ambient humidity | Operating: 5% to 85% |
| Weight | Approx. 90 g |

- Note:** 1. The values given above are initial values.
2. P level: $\lambda_{60} = 0.1 \times 10^{-6}/\text{operation}$
3. Ambient temperature of models with LED indicator is -25 to 60°C.

Approved Standards

UL508 (File No. E41515)

| Coil ratings | Contact ratings | Operations |
|------------------------------|--|------------|
| 6 to 110 VDC 6 to 240 VAC | N.O. contact 10 A, 250 V AC 50/60 Hz (Resistive) 10 A, 30 V DC (Resistive) 7 A, 250 V AC 50/60 Hz (General Use) | 100,000 |
| | N.C. contact 10 A, 250 V AC 50/60 Hz (Resistive) 10 A, 30 V DC (Resistive) 7 A, 250 V AC 50/60 Hz (General Use) | 100,000 |

CSA Standard: CSA Certification by

 **US: CSA C22.2 No. 14**

IEC Standard/TUV Certification: IEC61810-1 (Certification No. R50104853)

| Coil ratings | Contact ratings | Operations |
|--|--|------------|
| 6, 12, 24, 48, 100, 110 VDC 6, 12, 24, 100, 110, 200, 220, 240 VAC | N.O. contact 10 A, 250 V AC 50/60 Hz (Resistive) 10 A, 30 V DC (Resistive) 7 A, 250 V AC 50/60 Hz (General Use) | 100,000 |
| | N.C. contact 5 A, 250 V AC 50/60 Hz (Resistive) 5 A, 30 V DC (Resistive) 7 A, 250 V AC 50/60 Hz (General Use) | 100,000 |

Note: When Relays are mounted on the PF083A-E or PF113A-E, the maximum carrying current is 9 A.

Engineering Data

Reference Data

Maximum Switching Power

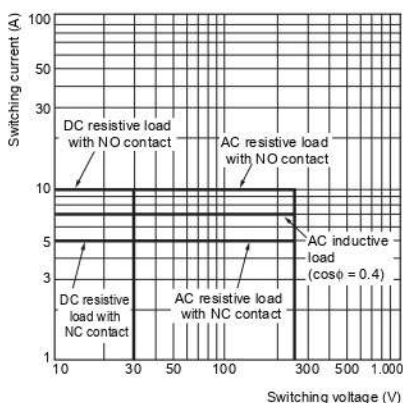

Rated Carry Current vs. Ambient Rated Temperature

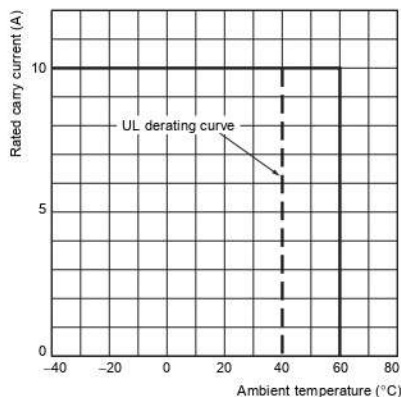

Note: The lower limit of the ambient operating temperature for models with built-in operation indicators is -25°C.

Dimensions

Models without Latching Lever

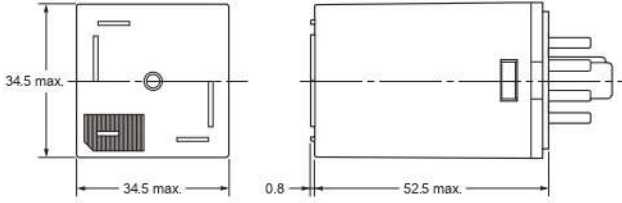



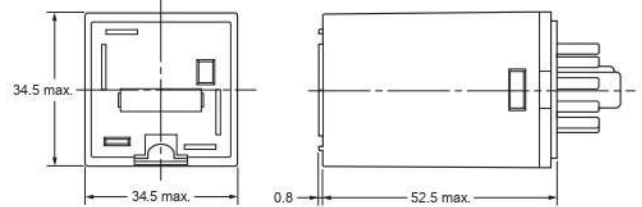



Models with Latching Lever



Sockets

See below for Socket dimensions.

| Socket | Surface-mounting Socket (for track or screw mounting) | | |
|------------------------------|---|---|---|
| | Finger-protection models | | --- |
| Maximum carry current | 10 A | | 5 A |
| 2 poles | PF083A-E  | PF083A-D  | PF083A  |
| 3 poles | PF113A-E  | PF113A-D  | PF113A  |

Note: Use the Surface-mounting Sockets (i.e., finger-protection models) with “-E” at the end of the model number. When using the PF083A and PF113A, be sure not to exceed the Socket’s maximum carry current of 5 A. Using at a current exceeding 5 A may lead to burning. Round terminals cannot be used for finger-protection models. Use Y-shaped terminals.

PF083A-E (Conforming to EN 50022)

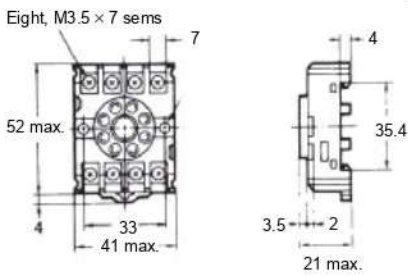

Terminal Arrangement

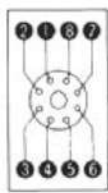

Mounting Holes

Two, M4 or two 4.5-dia. holes

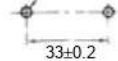

PF113A-E (Conforming to EN 50022)

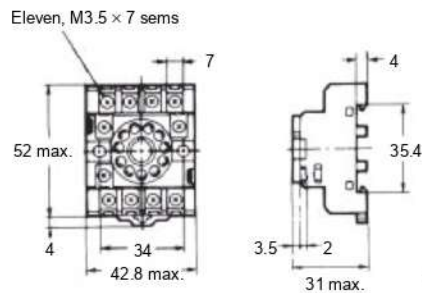

Terminal Arrangement

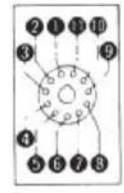

Mounting Holes

Two, M4 or two 4.5-dia. holes

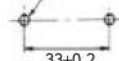

PF083A-D

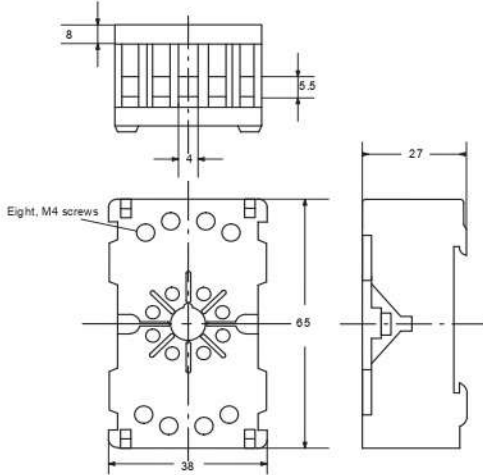

Terminal Arrangement

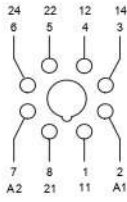

Mounting Holes

Two, M4 or two 4.5-dia. hole

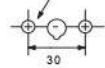

PF113A-D

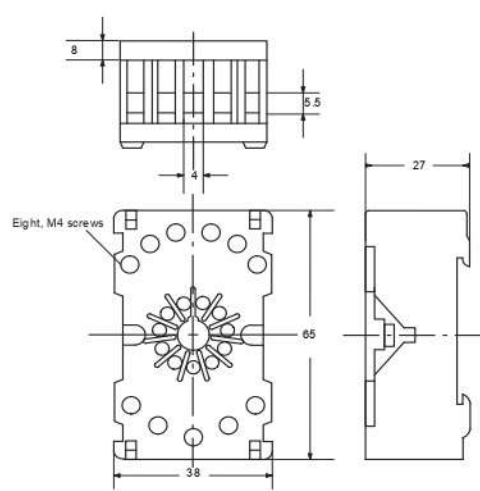

Terminal Arrangement

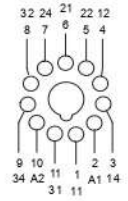

Mounting Holes

Two, M4 or two 4.5-dia. hole

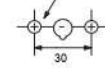

Hold-down Clips

PFC-A1

(2 pieces per set)

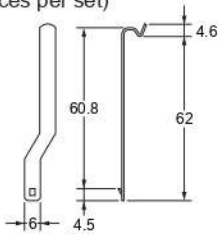

Mounting Tracks

**PFP-100N, PFP-50N
(Conforming to EN 50022)**

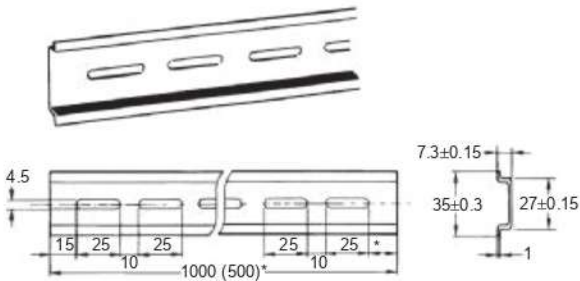

* This dimension applies to the PFP-50N Mounting Track.

**PFP-100N2
(Conforming to EN 50022)**

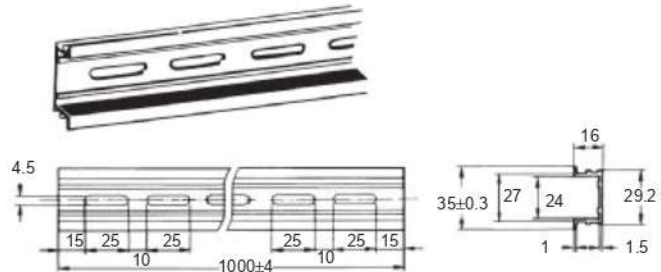

* A total of twelve 25 × 4.5 elliptic holes is provided with six holes cut from each track end at a pitch of 10 mm.

Mounting Height with Sockets

Surface-mounting Sockets

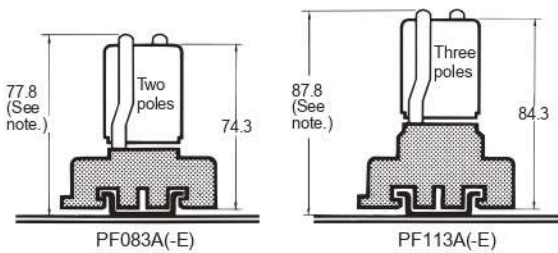

Note: PF083A(-E) and PF113A(-E) allow either track or screw mounting.

Terminal Arrangement and Internal Connection (Bottom View)

**Standard Models
(AC/DC Coil)**

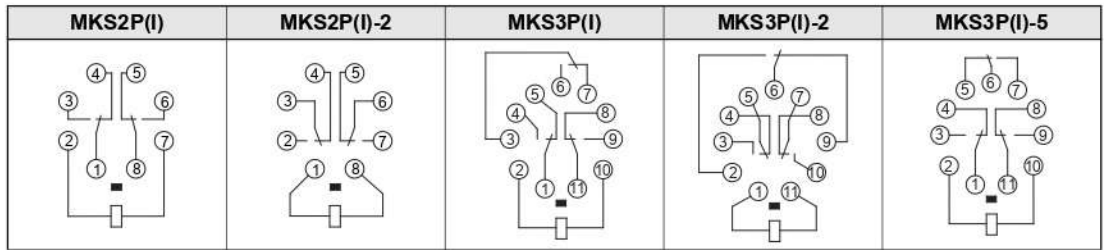

**Models with
LED Indicator
(AC Coil)**

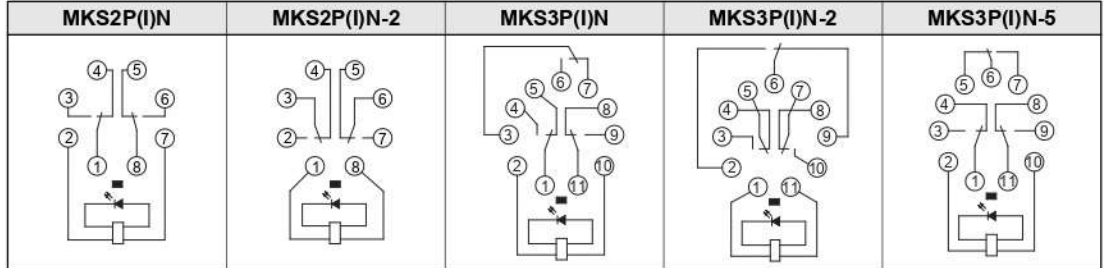

**Models with Diode
(DC Coil:
Standard Polarity)**

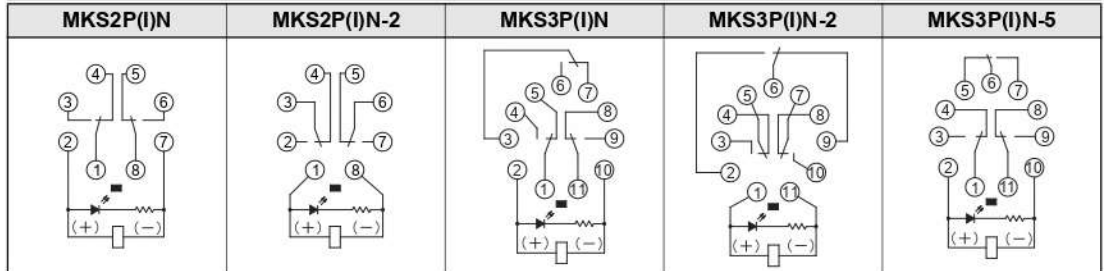

**Models with
LED Indicator and Diode
(DC Coil:
Reverse Polarity)**

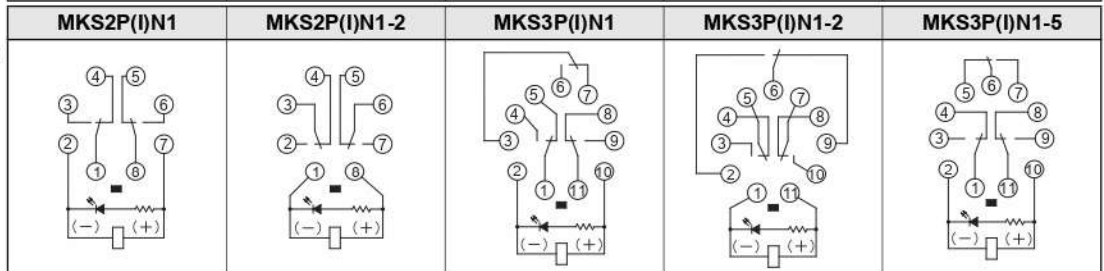

**Standard Models
(DC Coil:
Standard Polarity)**

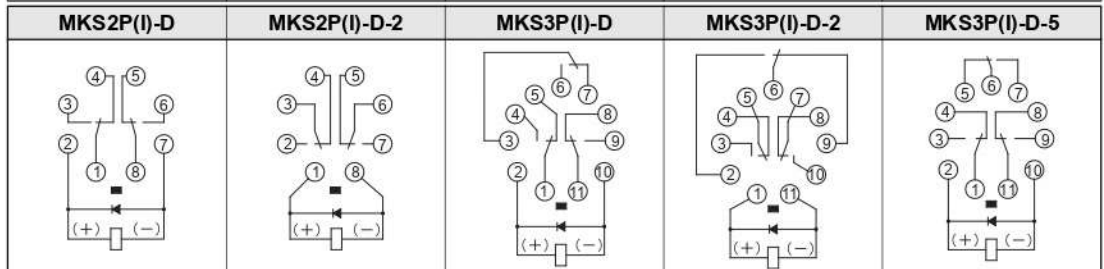

**Models with Diode
(DC Coil:
Reverse Polarity)**

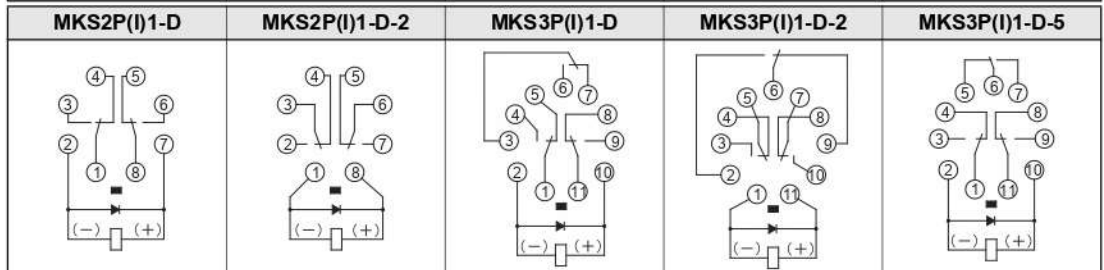

**Models with
LED indicator
(DC Coil)**

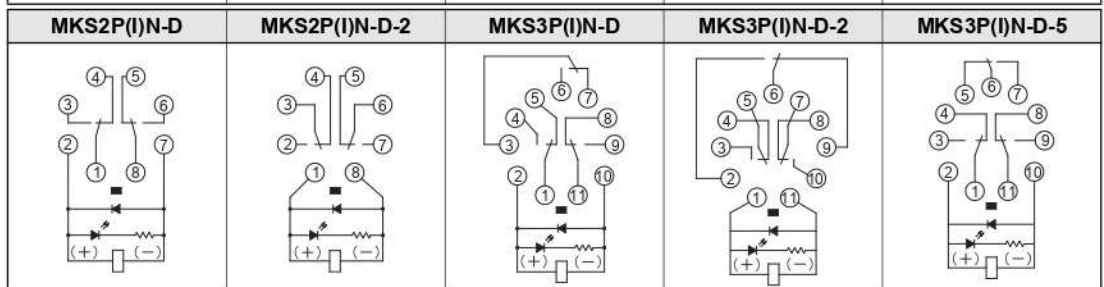

**Models with Varistor
(AC Coil)**

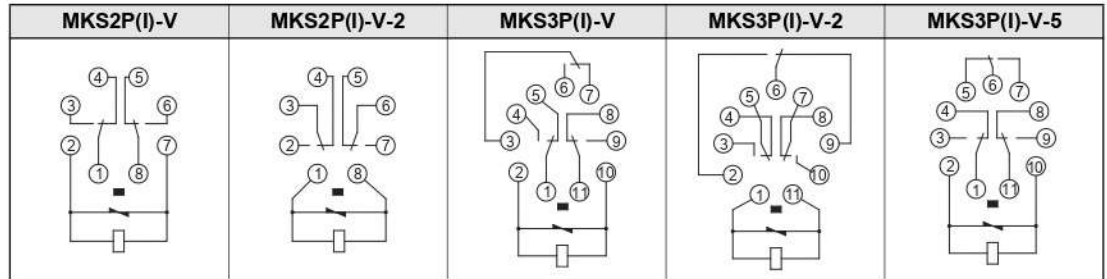

**Models with
LED indicator and
Varistor
(AC Coil)**

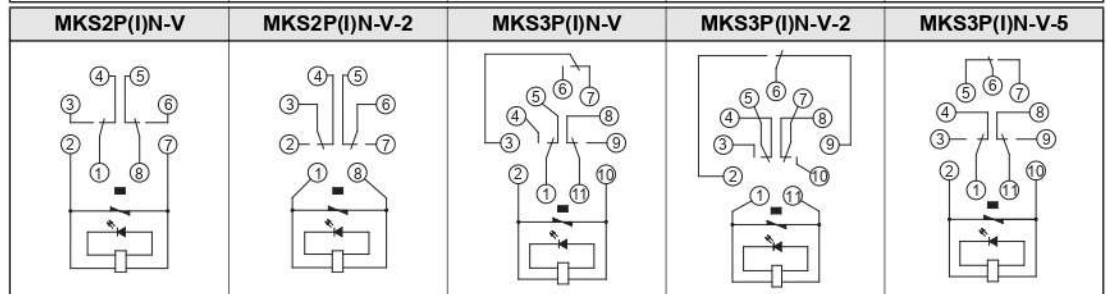

Safety Precautions for Correct Use

Installation

Mount the MK-S with the marking at the bottom.

Handling

Check the coil polarity of models with built-in diodes and wire them correctly (DC operation coil).

Test Button

Do not use the test button for any purpose other than testing. Be sure not to touch the test button accidentally as this will turn the contacts ON. Before using the test button, confirm that circuits, the load, and any other connected item will operate safely.

Check that the test button is released before turning ON relay circuits.

If the test button is pulled out too forcefully, it may bypass the momentary testing position and go straight into the locked position.

Use an insulated tool when you operate the test button.

Models with test buttons or LED indicators fulfill the requirements for reinforced insulation between live parts and the front of cover only when the Relay is in a complete condition, i.e. with the nameplate, nameplate frame, test button, and slider in place. If any of these parts are removed, only the requirements for basic insulation are fulfilled.

Safety Precautions

Safety Precautions for Correct Use

Installation

Mount the MK-S with the marking at the bottom.

Handling

Check the coil polarity of models with built-in diodes and wire them correctly
(DC operation coil).

Test Button

Do not use the test button for any purpose other than testing. Be sure not to touch the test button accidentally as this will turn the contacts ON. Before using the test button, confirm that circuits, the load, and any other connected item will operate safely.

Check that the test button is released before turning ON relay circuits. If the test button is pulled out too forcefully, it may bypass the momentary testing position and go straight into the locked position. Use an insulated tool when you operate the test button.

Models with test buttons or LED indicators fulfill the requirements for reinforced insulation between live parts and the front of cover only when the Relay is in a complete condition, i.e. with the nameplate, nameplate frame, test button, and slider in place. If any of these parts are removed, only the requirements for basic insulation are fulfilled.