

$$I_{F(AV)} = 30\text{Amp}$$

$$V_R = 150\text{V}$$

**Major Ratings and Characteristics**

Characteristics	Value	Units
$I_{F(AV)}$ Rectangular waveform	30	A
$V_{RRM}$	150	V
$I_{FSM}$ @ tp = 5 $\mu$ s sine	1000	A
$V_F$ @ 15 Apk, $T_J = 125^\circ\text{C}$ (per leg)	0.78	V
$T_J$	-55 to 175	$^\circ\text{C}$

**Description/ Features**

The 30CPQ150 center tap Schottky rectifier series has been optimized for low reverse leakage at high temperature. The proprietary barrier technology allows for reliable operation up to 175 $^\circ\text{C}$  junction temperature. Typical applications are in switching power supplies, converters, free-wheeling diodes, and reverse battery protection.

- 175 $^\circ\text{C}$   $T_J$  operation
- Center tap TO-247 package
- High purity, high temperature epoxy encapsulation for enhanced mechanical strength and moisture resistance
- Low forward voltage drop
- High frequency operation
- Guard ring for enhanced ruggedness and long term reliability

**Case Styles**



**TO-247AC**

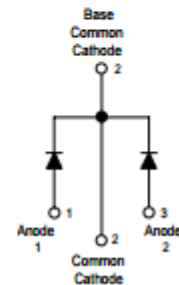

**Voltage Ratings**

Part number	30CPQ150
$V_R$ Max. DC Reverse Voltage (V)	150
$V_{RRM}$ Max. Working Peak Reverse Voltage (V)	

**Absolute Maximum Ratings**

Parameters	30CPQ	Units	Conditions
$I_{F(AV)}$ Max. Average Forward Current * See Fig. 5	30	A	50% duty cycle @ $T_c = 135^\circ\text{C}$ , rectangular wave form
Per Device	15		
$I_{FSM}$ Max. Peak One Cycle Non-Repetitive Surge Current (Per Leg) * See Fig. 7	1000	A	5 $\mu$ s Sine or 3 $\mu$ s Rect. pulse
	340		10ms Sine or 6ms Rect. pulse
$E_{AS}$ Non-Repetitive Avalanche Energy (Per Leg)	11.25	mJ	$T_J = 25^\circ\text{C}$ , $I_{AS} = 0.50$ Amps, $L = 90$ mH
$I_{AR}$ Repetitive Avalanche Current (Per Leg)	0.50	A	Current decaying linearly to zero in 1 $\mu$ sec Frequency limited by $T_J$ max. $V_A = 1.5 \times V_R$ typical

## Electrical Specifications

Parameters	30CPQ	Units	Conditions
$V_{FM}$ Max. Forward Voltage Drop (Per Leg) * See Fig. 1 (1)	1.00	V	@ 15A
	1.19	V	@ 30A
	0.78	V	@ 15A
	0.93	V	@ 30A
$I_{RM}$ Max. Reverse Leakage Current (Per Leg) * See Fig. 2 (1)	0.1	mA	$T_J = 25^\circ\text{C}$
	15	mA	$T_J = 125^\circ\text{C}$
$C_T$ Max. Junction Capacitance (Per Leg)	340	pF	$V_R = 5V_{DC}$ (test signal range 100Khz to 1Mhz) $25^\circ\text{C}$
$L_S$ Typical Series Inductance (Per Leg)	7.5	nH	Measured lead to lead 5mm from package body
$dv/dt$ Max. Voltage Rate of Change (Rated $V_R$ )	10000	V/ $\mu\text{s}$	

(1) Pulse Width < 300 $\mu\text{s}$ , Duty Cycle <2%

## Thermal-Mechanical Specifications

Parameters	30CPQ	Units	Conditions
$T_J$ Max. Junction Temperature Range	-55 to 175	$^\circ\text{C}$	
$T_{stg}$ Max. Storage Temperature Range	-55 to 175	$^\circ\text{C}$	
$R_{thJC}$ Max. Thermal Resistance Junction to Case (Per Leg)	2.20	$^\circ\text{C/W}$	DC operation * See Fig. 4
$R_{thJC}$ Max. Thermal Resistance Junction to Case (Per Package)	1.10	$^\circ\text{C/W}$	DC operation
$R_{thCS}$ Typical Thermal Resistance, Case to Heatsink	0.24	$^\circ\text{C/W}$	Mounting surface, smooth and greased
wt Approximate Weight	6(0.21)	g(oz.)	
T Mounting Torque	Min. 6(5)	Kg-cm (lbf-in)	
	Max. 12(10)		
Case Style	TO-247AC(TO-3P)	JEDEC	
Marking Device	30CPQ150		

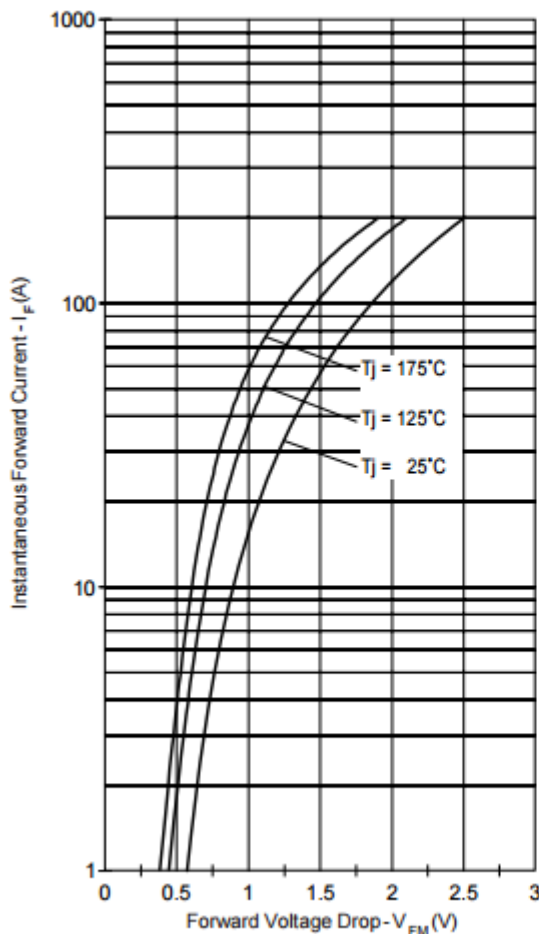

Fig. 1 - Max. Forward Voltage Drop Characteristics (Per Leg)

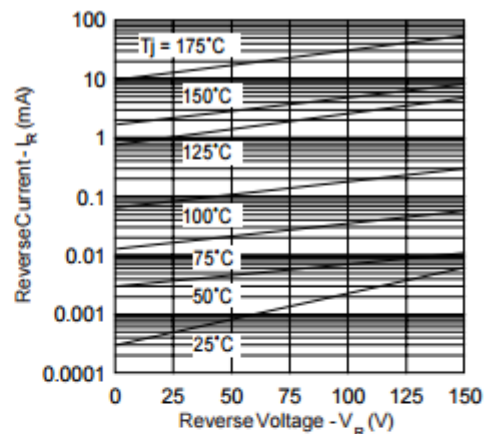

Fig. 2 - Typical Values Of Reverse Current Vs. Reverse Voltage (Per Leg)

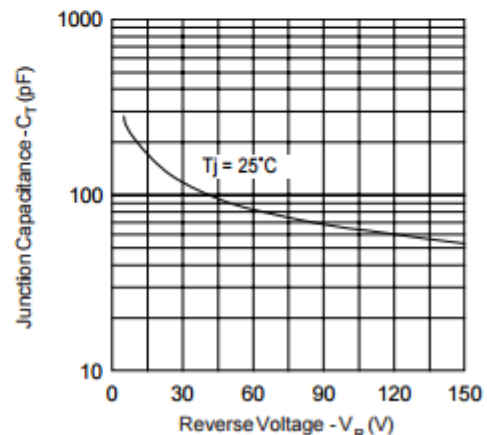

Fig. 3 - Typical Junction Capacitance Vs. Reverse Voltage (Per Leg)

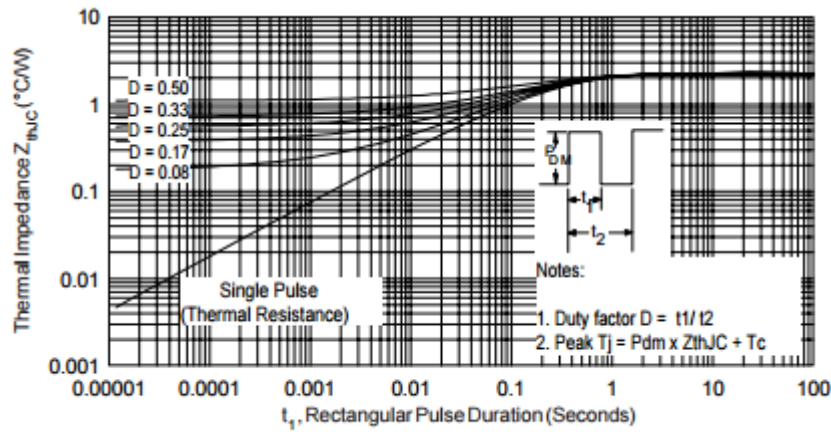

Fig. 4- Max. Thermal Impedance  $Z_{thJC}$  Characteristics (Per Leg)

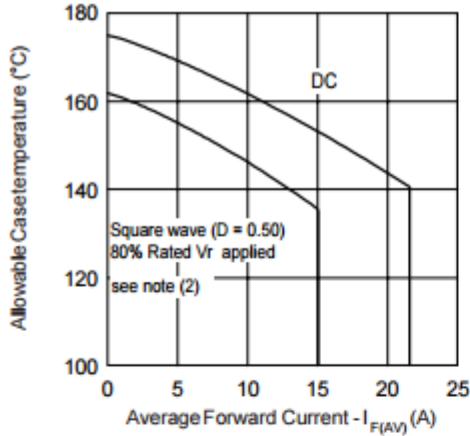

Fig. 5- Max. Allowable Case Temperature Vs. Average Forward Current (Per Leg)

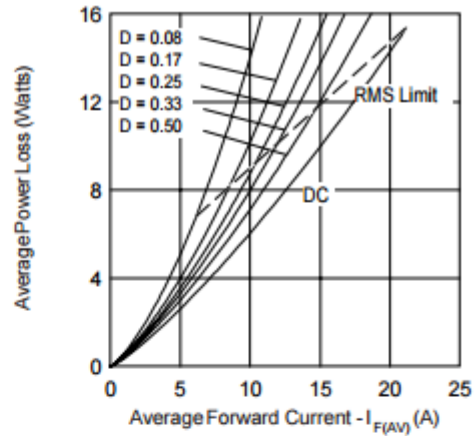

Fig. 6- Forward Power Loss Characteristics (Per Leg)

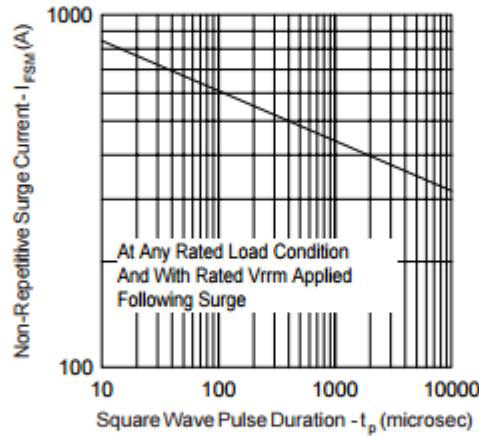

Fig. 7- Max. Non-Repetitive Surge Current (Per Leg)

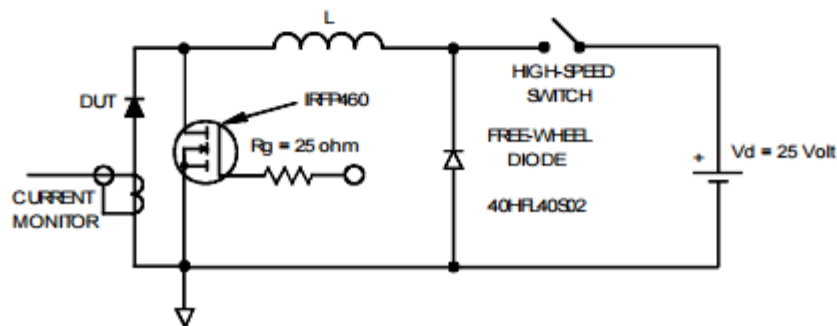
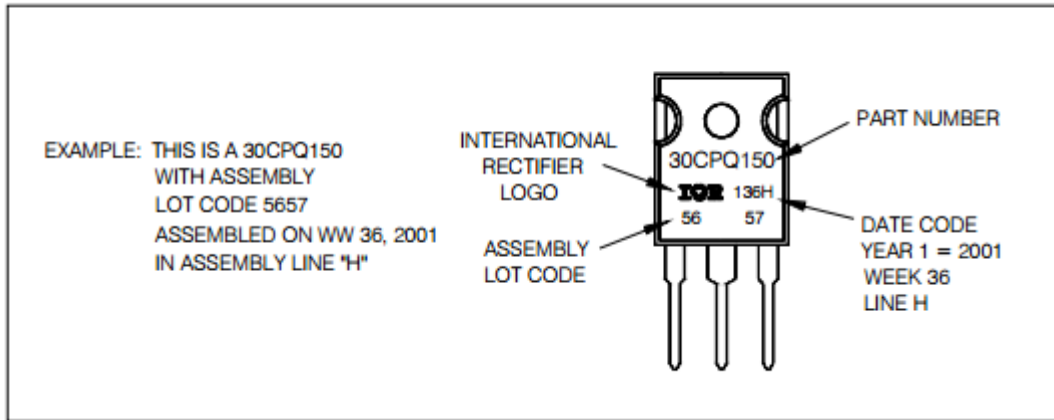

Fig. 8- Unclamped Inductive Test Circuit

## Marking Information



## Ordering Information Table

Device Code					
30	C	P	Q	150	-
①	②	③	④	⑤	⑥
<b>1</b>	-	Current Rating (30 = 30A)			
<b>2</b>	-	Circuit Configuration			
		C = Common Cathode			
<b>3</b>	-	Package			
		P = TO-247			
<b>4</b>	-	Schottky "Q" Series			
<b>5</b>	-	Voltage Code (150 = 150V)			
<b>6</b>	-	• none = Standard Production			
		• PbF = Lead-Free			
Tube Standard Pack Quantity : 25 pieces					