

FYLS - 1210SR/YGC

Radiation pattern.

Features:

- Compatible with automatic placement equipment
- Compatible with reflow solder process.

Applications:

- Automotive-Telecommunication
- Indicators
- Lcd Back-lights
- Illuminations

Descriptions:

- Dice material: R: AlGaInP
G: AlGaInP
- Emitting Color: R: Super Deep-Red.
G: Super Yellow Green.
- Lens Color: Water clear.

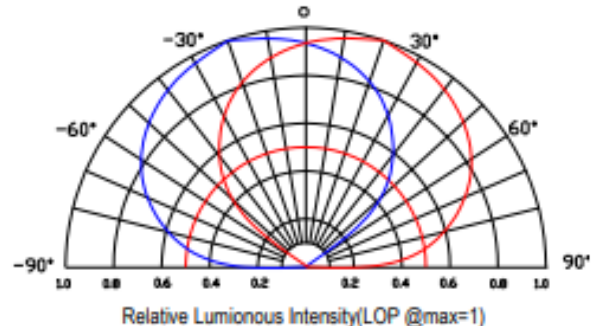

Absolute maximum ratings(Ta=25 °c)

Parameter	MAX.	Unit
Power Dissipation	60	mW
Peak Forward Current (1/10 Duty Cycle, 0.1ms Pulse)	60	mA
Continuous Forward Current	20	mA
Derating Linear From 25°C	0.4	mA/°C
Operating Temperature Range	-30°C to +80°C	
Storage Temperature Range	-40°C to +85°C	
Soldering Temperature	260°C (for 5 second)	

Electrical and optical characteristics(Ta=25 °c)

Parameter	Symbol	Min.	Typ.	Max.	Unit	Test Condition	
Luminous Intensity	IV	R	25	30	-	mcd	IF=20mA
		G	16	25	-		
Viewing Angle	2θ1/2	120	130	140	Deg		
Peak Emission Wavelength	λp	R	-	650	-	nm	
		G	-	575	-		
Dominant Wavelength	λd	R	634	639	644	nm	
		G	568	573	578		
Spectral Line Half-Width	Δλ	25	30	35	nm		
Forward Voltage	VF	R	-	2.0	2.4	V	
		G	-	2.0	2.4		
Reverse Current	IR			10	μA	VR=5V	

**Typical Electrical Characteristics Curves
(25 °c Ambient Temperature Unless Otherwise Noted)**

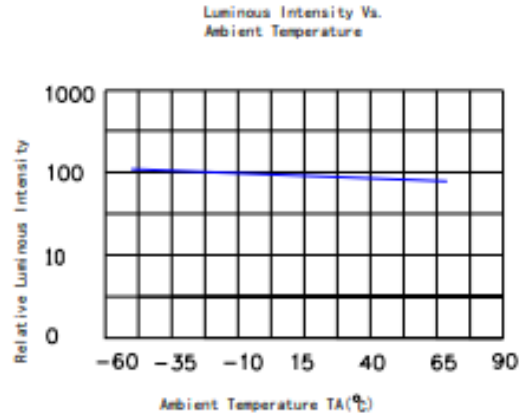
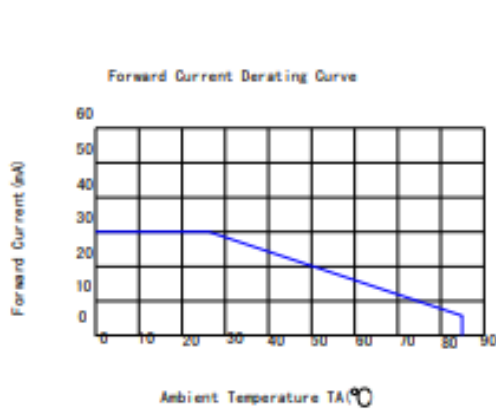
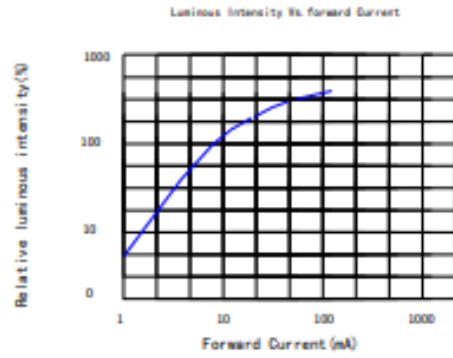
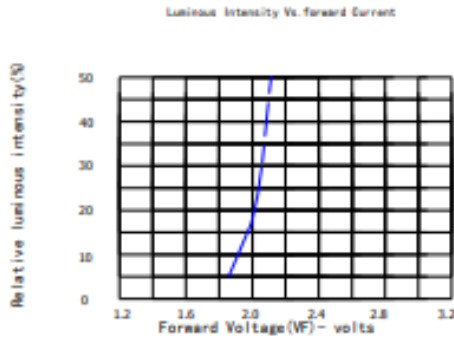
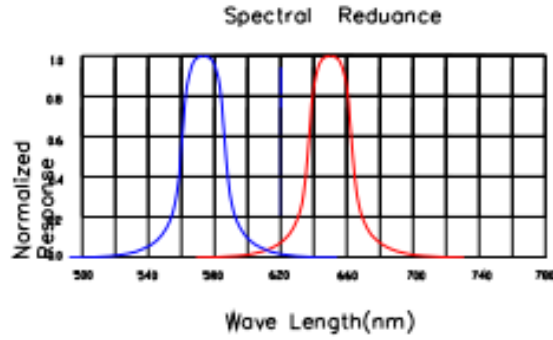

◆ Precautions For Use**● Over-current-proof**

Customer must apply resistors for protection, otherwise slight voltage shift will cause big current change (Burn out will happen)

● Storage

1. The operation of temperature and R.H are: $5^{\circ}\text{C} - 30^{\circ}\text{C}$, R.H. 60% Max.
2. Once the package is opened, the products should be used within a week. Otherwise, they should be kept in a damp-proof box with desiccating reagent. Considering the tape life, we suggest our customers to use our products within 1.5 year (from production date).
3. It's recommended to bake before soldering when the package is unsealed after 72hrs. The condition is: $60^{\circ}\text{C} \pm 5^{\circ}\text{C}$ for 15 hrs.

◆ Soldering Iron:

- Temperature at tip of iron: 300°C Max. (25W Max)
- Soldering time: 3 ± 1 sec.

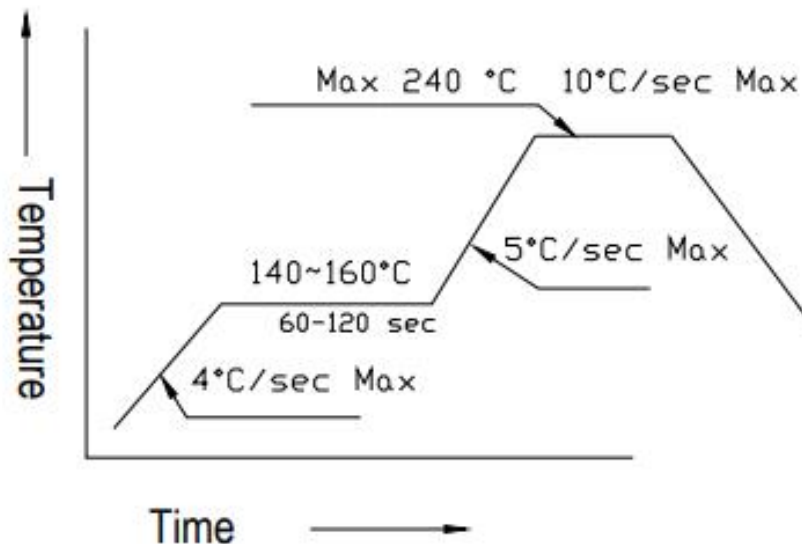
◆ Reflow Temp./Time:

◆ Package Dimensions of Device

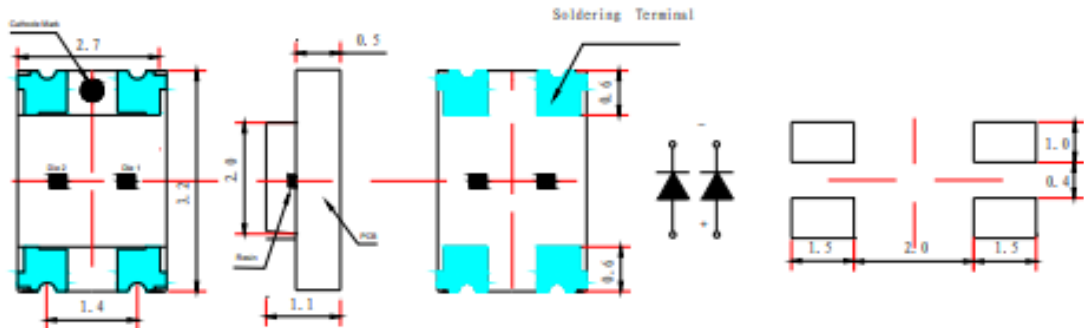

Unit:mm

◆ Tape Specification: 3000pcs Per Reel.

Packing Size								
Item	W	P1	E	F	D0	D1	P0	Unit
Spec.	8.00	4.00	1.75	3.50	1.50	1.00	4.00	mm
Tolerance	±0.20	±0.10	±0.10	±0.05	+0.1/-0	±0.05	±0.05	mm
Item	10P0	P2	A0	B0	K0	T		Unit
Spec.	40.00	2.00	2.80	3.35	1.35	0.22		mm
Tolerance	±0.20	±0.05	±0.10	±0.10	±0.10	±0.05		mm

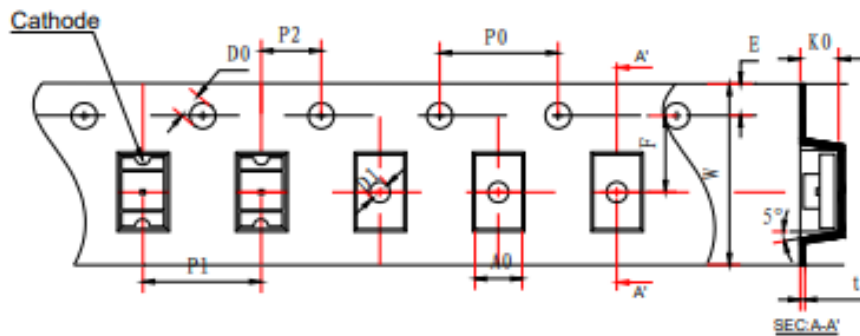

◆ Package Dimensions of Reel:

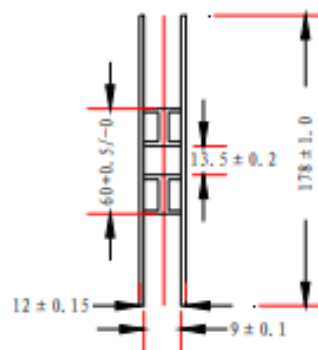
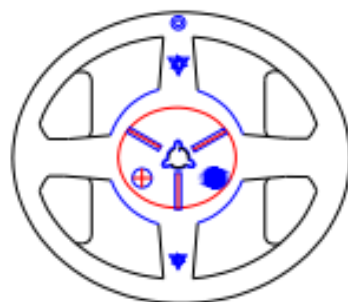

Unit:mm

◆ Packing and Shipping Spec.

