

Cool MOS™ Power Transistor

Feature

- New revolutionary high voltage technology
- Worldwide best $R_{DS(on)}$ in TO 220
- Ultra low gate charge
- Periodic avalanche rated
- Extreme dv/dt rated
- Ultra low effective capacitances
- Improved transconductance
- P-TO-220-3-31: Fully isolated package (2500 VAC; 1 minute)

V_{DS}	800	V
$R_{DS(on)}$	0.29	Ω
I_D	17	A

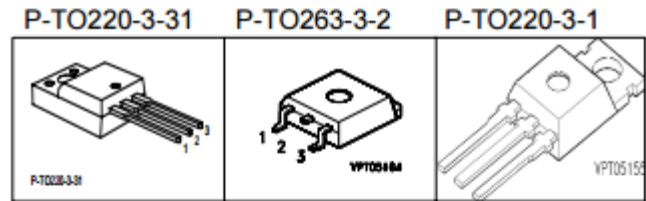

Type	Package	Ordering Code	Marking
SPP17N80C3	P-TO220-3-1	Q67040-S4353	17N80C3
SPB17N80C3	P-TO263-3-2	Q67040-S4354	17N80C3
SPA17N80C3	P-TO220-3-31	Q67040-S4441	17N80C3

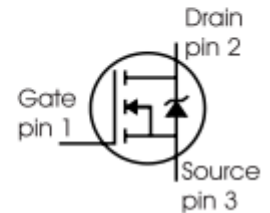

Maximum Ratings

Parameter	Symbol	Value		Unit
		SPP_B	SPA	
Continuous drain current $T_C = 25\text{ }^\circ\text{C}$ $T_C = 100\text{ }^\circ\text{C}$	I_D	17 11	17 ¹⁾ 11 ¹⁾	A
Pulsed drain current, t_p limited by T_{jmax}	$I_{D\text{ puls}}$	51	51	A
Avalanche energy, single pulse $I_D=3.4\text{A}, V_{DD}=50\text{V}$	E_{AS}	670	670	mJ
Avalanche energy, repetitive t_{AR} limited by T_{jmax} ²⁾ $I_D=17\text{A}, V_{DD}=50\text{V}$	E_{AR}	0.5	0.5	
Avalanche current, repetitive t_{AR} limited by T_{jmax}	I_{AR}	17	17	A
Gate source voltage	V_{GS}	± 20	± 20	V
Gate source voltage AC ($f > 1\text{Hz}$)	V_{GS}	± 30	± 30	
Power dissipation, $T_C = 25\text{ }^\circ\text{C}$	P_{tot}	208	42	W
Operating and storage temperature	T_j, T_{stg}	-55...+150		$^\circ\text{C}$

Maximum Ratings

Parameter	Symbol	Value	Unit
Drain Source voltage slope $V_{DS} = 640\text{ V}, I_D = 17\text{ A}, T_j = 125\text{ }^\circ\text{C}$	dv/dt	50	V/ns

Thermal Characteristics

Parameter	Symbol	Values			Unit
		min.	typ.	max.	
Thermal resistance, junction - case	R_{thJC}	-	-	0.6	K/W
Thermal resistance, junction - case, FullPAK	R_{thJC_FP}	-	-	3.6	
Thermal resistance, junction - ambient, leaded	R_{thJA}	-	-	62	
Thermal resistance, junction - ambient, FullPAK	R_{thJA_FP}	-	-	80	
SMD version, device on PCB: @ min. footprint @ 6 cm ² cooling area ³⁾	R_{thJA}	-	-	62	
		-	35	-	
Soldering temperature, 1.6 mm (0.063 in.) from case for 10s ⁴⁾	T_{sold}	-	-	260	°C

Electrical Characteristics, at $T_j=25^\circ\text{C}$ unless otherwise specified

Parameter	Symbol	Conditions	Values			Unit
			min.	typ.	max.	
Drain-source breakdown voltage	$V_{(BR)DSS}$	$V_{GS}=0V, I_D=0.25mA$	800	-	-	V
Drain-Source avalanche breakdown voltage	$V_{(BR)DS}$	$V_{GS}=0V, I_D=17A$	-	870	-	
Gate threshold voltage	$V_{GS(th)}$	$I_D=1000\mu A, V_{GS}=V_D$	2.1	3	3.9	
Zero gate voltage drain current	I_{DSS}	$V_{DS}=800V, V_{GS}=0V,$ $T_j=25^\circ\text{C}$ $T_j=150^\circ\text{C}$	-	0.5	25	μA
			-	-	250	
Gate-source leakage current	I_{GSS}	$V_{GS}=20V, V_{DS}=0V$	-	-	100	nA
Drain-source on-state resistance	$R_{DS(on)}$	$V_{GS}=10V, I_D=11A$ $T_j=25^\circ\text{C}$ $T_j=150^\circ\text{C}$	-	0.25	0.29	Ω
			-	0.78	-	
Gate input resistance	R_G	$f=1MHz, \text{open drain}$	-	0.7	-	

Electrical Characteristics

Parameter	Symbol	Conditions	Values			Unit
			min.	typ.	max.	
Transconductance	g_{fs}	$V_{DS} \geq 2 \cdot I_D \cdot R_{DS(on)max}$ $I_D = 11A$	-	15	-	S
Input capacitance	C_{iss}	$V_{GS} = 0V, V_{DS} = 25V,$ $f = 1MHz$	-	2320	-	pF
Output capacitance	C_{oss}		-	1250	-	
Reverse transfer capacitance	C_{rss}		-	60	-	
Effective output capacitance, ⁵⁾ energy related	$C_{o(er)}$		$V_{GS} = 0V,$ $V_{DS} = 0V \text{ to } 480V$	-	59	
Effective output capacitance, ⁶⁾ time related	$C_{o(tr)}$		-	124	-	
Turn-on delay time	$t_{d(on)}$	$V_{DD} = 400V, V_{GS} = 0/10V,$ $I_D = 17A,$ $R_G = 4.7\Omega, T_j = 125^\circ C$	-	25	-	ns
Rise time	t_r		-	15	-	
Turn-off delay time	$t_{d(off)}$		-	72	82	
Fall time	t_f		-	6	9	

Gate Charge Characteristics

Gate to source charge	Q_{gs}	$V_{DD} = 640V, I_D = 17A$	-	12	-	nC
Gate to drain charge	Q_{gd}		-	46	-	
Gate charge total	Q_g	$V_{DD} = 640V, I_D = 17A,$ $V_{GS} = 0 \text{ to } 10V$	-	91	177	
Gate plateau voltage	$V_{(plateau)}$	$V_{DD} = 640V, I_D = 17A$	-	6	-	V

¹Limited only by maximum temperature

²Repetitive avalanche causes additional power losses that can be calculated as $P_{AV} = E_{AR} \cdot f$.

³Device on 40mm*40mm*1.5mm epoxy PCB FR4 with 6cm² (one layer, 70 μm thick) copper area for drain connection. PCB is vertical without blown air.

⁴Soldering temperature for TO-263: 220°C, reflow

⁵ $C_{o(er)}$ is a fixed capacitance that gives the same stored energy as C_{oss} while V_{DS} is rising from 0 to 80% V_{DSS} .

⁶ $C_{o(tr)}$ is a fixed capacitance that gives the same charging time as C_{oss} while V_{DS} is rising from 0 to 80% V_{DSS} .

Electrical Characteristics

Parameter	Symbol	Conditions	Values			Unit
			min.	typ.	max.	
Inverse diode continuous forward current	I_S	$T_C=25^\circ\text{C}$	-	-	17	A
Inverse diode direct current, pulsed	I_{SM}		-	-	51	
Inverse diode forward voltage	V_{SD}	$V_{GS}=0\text{V}, I_F=I_S$	-	1	1.2	V
Reverse recovery time	t_{rr}	$V_R=400\text{V}, I_F=I_S,$	-	550	-	ns
Reverse recovery charge	Q_{rr}	$di_F/dt=100\text{A}/\mu\text{s}$	-	15	-	μC
Peak reverse recovery current	I_{rrm}		-	51	-	A
Peak rate of fall of reverse recovery current	di_{rr}/dt	$T_j=25^\circ\text{C}$	-	1200	-	$\text{A}/\mu\text{s}$

Typical Transient Thermal Characteristics

Symbol	Value		Unit	Symbol	Value		Unit
	SPP_B	SPA			SPP_B	SPA	
R_{th1}	0.00812	0.00812	K/W	C_{th1}	0.0003562	0.0003562	Ws/K
R_{th2}	0.016	0.016		C_{th2}	0.001337	0.001337	
R_{th3}	0.031	0.031		C_{th3}	0.001831	0.001831	
R_{th4}	0.114	0.16		C_{th4}	0.005033	0.005033	
R_{th5}	0.135	0.324		C_{th5}	0.012	0.008657	
R_{th6}	0.059	2.522		C_{th6}	0.092	0.412	

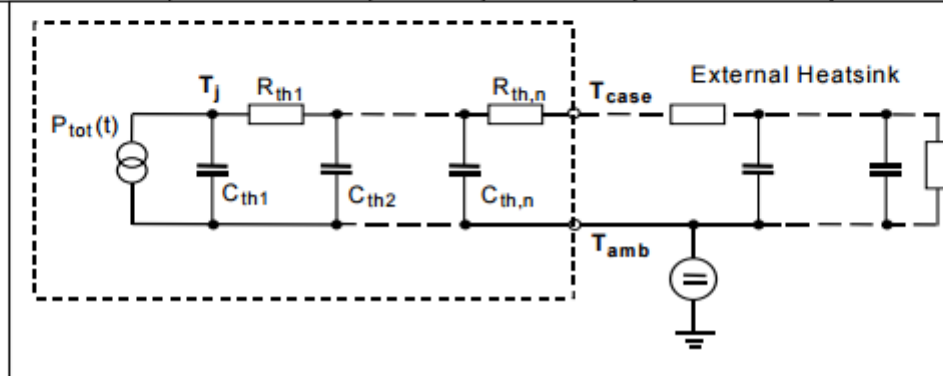

1 Power dissipation

$$P_{tot} = f(T_C)$$

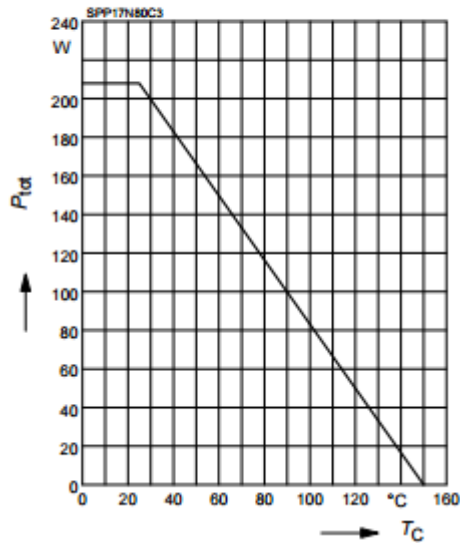

2 Power dissipation FullPAK

$$P_{tot} = f(T_C)$$

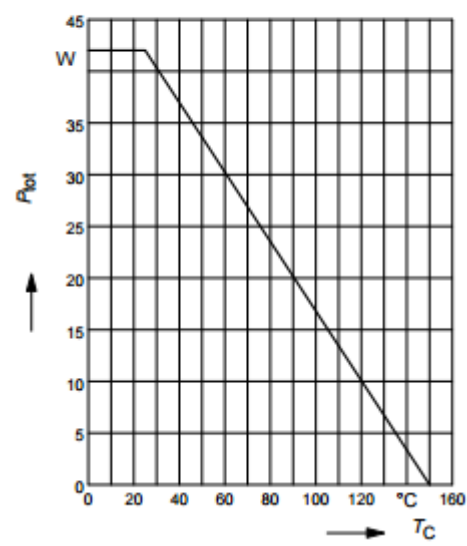

3 Safe operating area

$$I_D = f(V_{DS})$$

parameter: $D = 0$, $T_C = 25^\circ\text{C}$

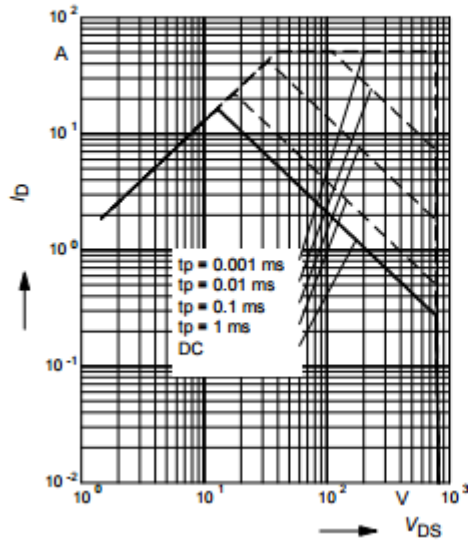

4 Safe operating area FullPAK

$$I_D = f(V_{DS})$$

parameter: $D = 0$, $T_C = 25^\circ\text{C}$

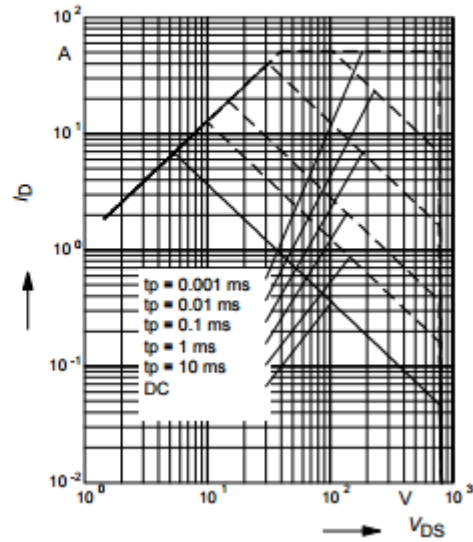

5 Transient thermal impedance

$$Z_{thJC} = f(t_p)$$

parameter: $D = t_p/t$

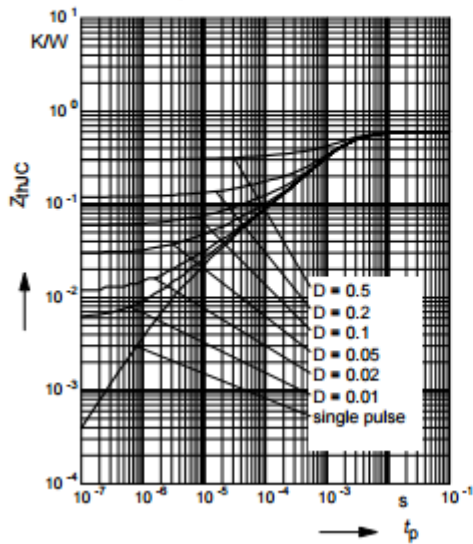

6 Transient thermal impedance FullPAK

$$Z_{thJC} = f(t_p)$$

parameter: $D = t_p/t$

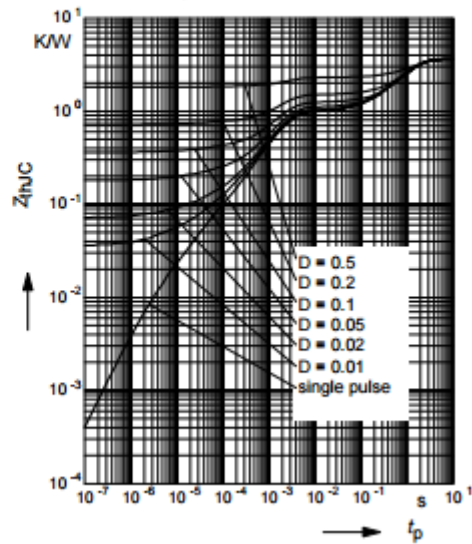

7 Typ. output characteristic

$$I_D = f(V_{DS}); T_J = 25^\circ\text{C}$$

parameter: $t_p = 10 \mu\text{s}$, V_{GS}

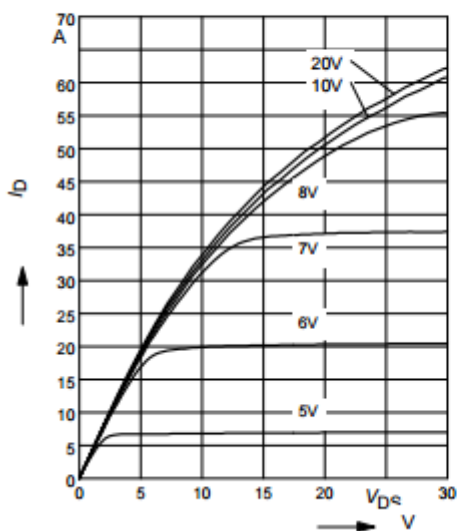

8 Typ. output characteristic

$$I_D = f(V_{DS}); T_J = 150^\circ\text{C}$$

parameter: $t_p = 10 \mu\text{s}$, V_{GS}

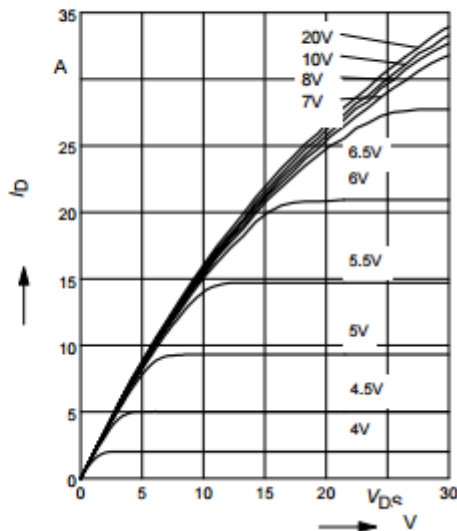

9 Typ. drain-source on resistance

$$R_{DS(on)} = f(I_D)$$

parameter: $T_J = 150^\circ\text{C}$, V_{GS}

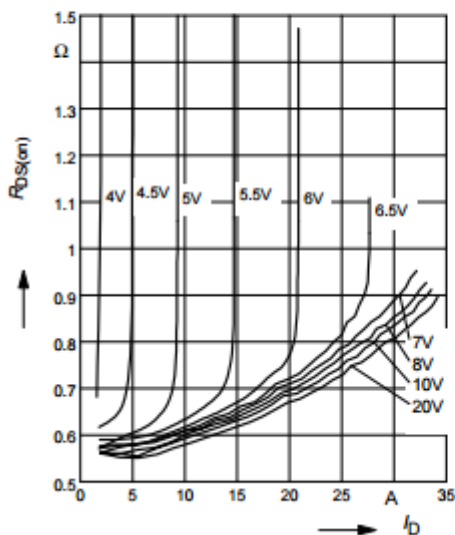

10 Drain-source on-state resistance

$$R_{DS(on)} = f(T_J)$$

parameter: $I_D = 11 \text{ A}$, $V_{GS} = 10 \text{ V}$

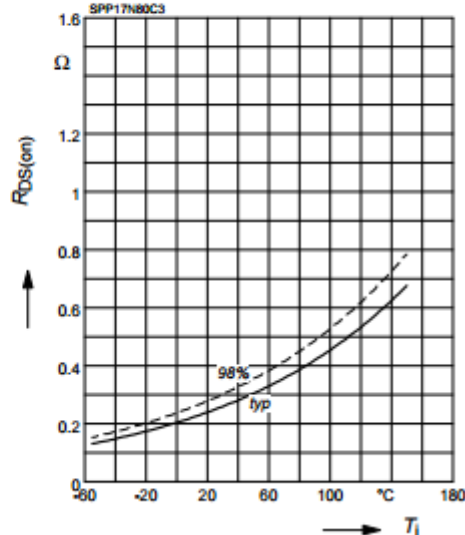

11 Typ. transfer characteristics

$$I_D = f(V_{GS}); V_{DS} \geq 2 \times I_D \times R_{DS(on)max}$$

parameter: $t_p = 10 \mu\text{s}$

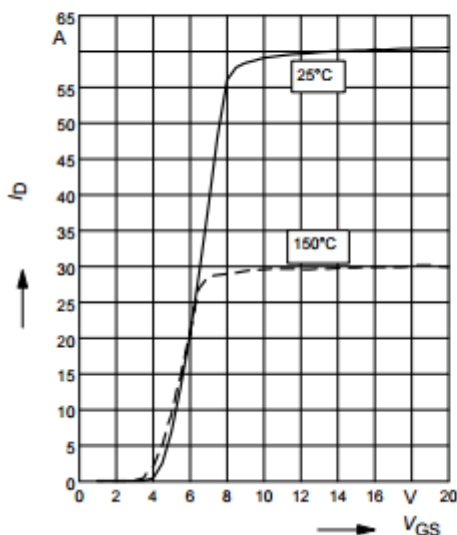

12 Typ. gate charge

$$V_{GS} = f(Q_{Gate})$$

parameter: $I_D = 17 \text{ A}$ pulsed

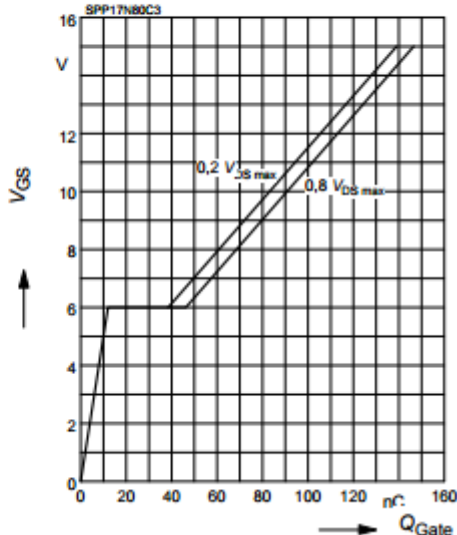

13 Forward characteristics of body diode

$$I_F = f(V_{SD})$$

parameter: T_j , $t_p = 10 \mu s$

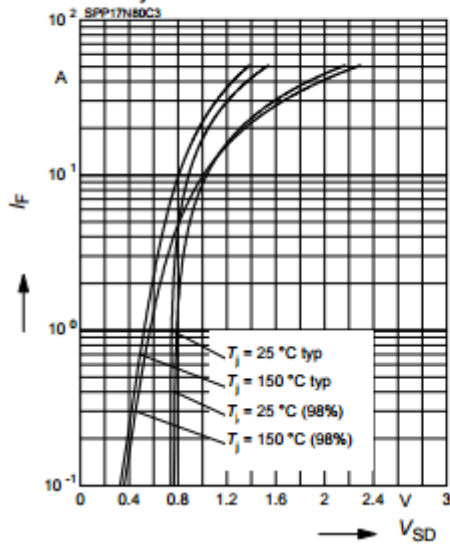

14 Avalanche SOA

$$I_{AR} = f(t_{AR})$$

par.: $T_j \leq 150 \text{ °C}$

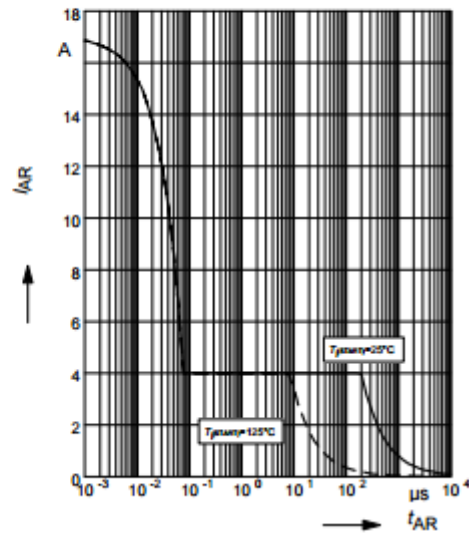

15 Avalanche energy

$$E_{AS} = f(T_j)$$

par.: $I_D = 3.4 \text{ A}$, $V_{DD} = 50 \text{ V}$

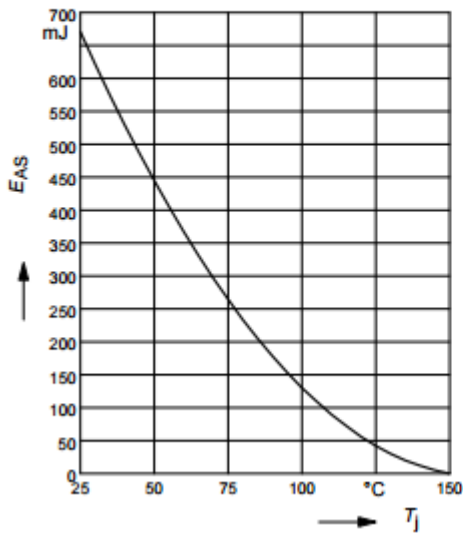

16 Drain-source breakdown voltage

$$V_{(BR)DSS} = f(T_j)$$

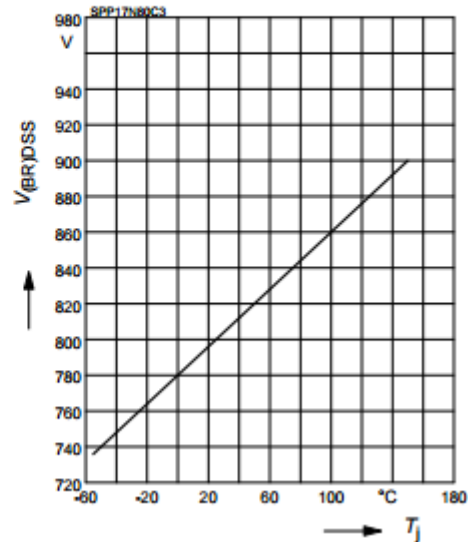

17 Avalanche power losses

$$P_{AR} = f(f)$$

parameter: $E_{AR} = 0.5 \text{ mJ}$

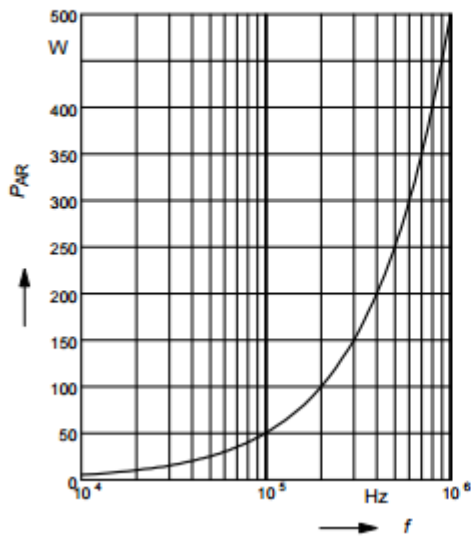

18 Typ. capacitances

$$C = f(V_{DS})$$

parameter: $V_{GS} = 0 \text{ V}$, $f = 1 \text{ MHz}$

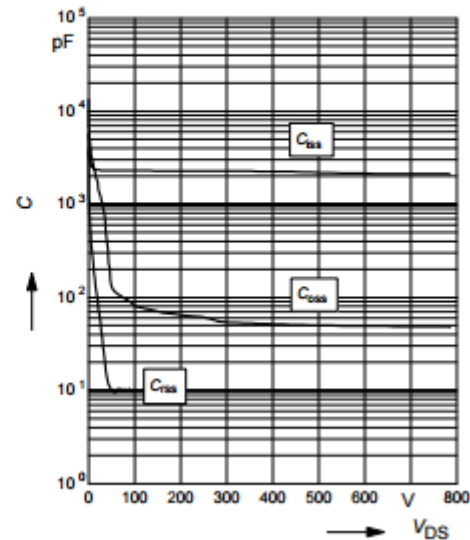

19 Typ. C_{OSS} stored energy

$E_{OSS} = f(V_{DS})$

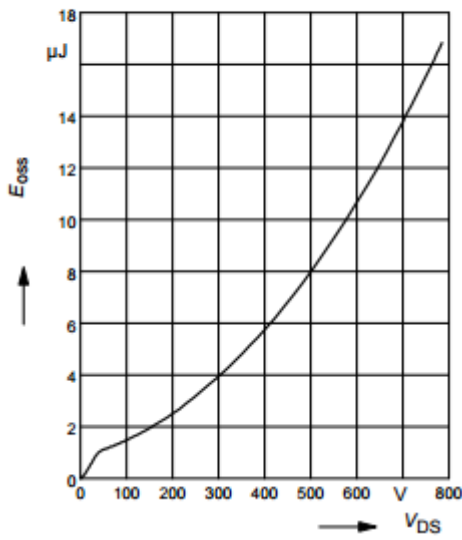

Definition of diodes switching characteristics

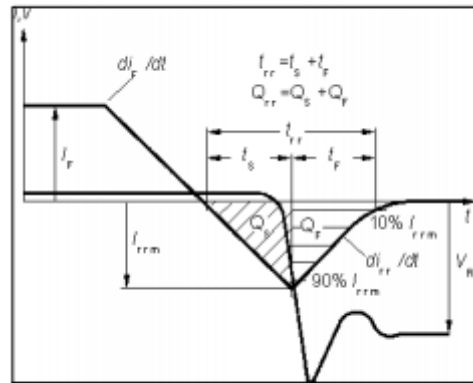

P-TO-220-3-1

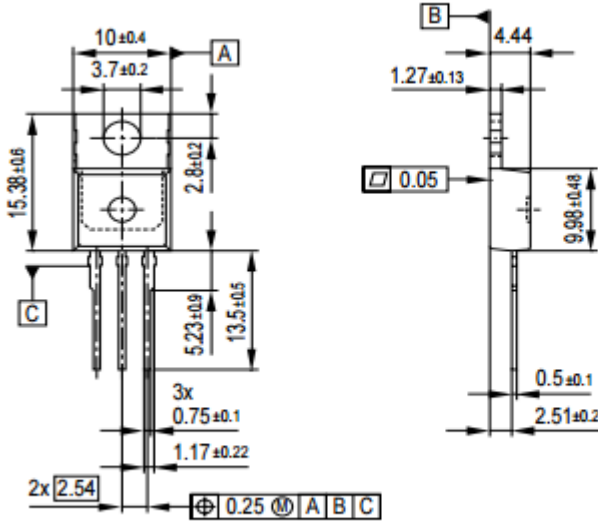

All metal surfaces tin plated, except area of cut.
Metal surface min. $x=7.25$, $y=12.3$

P-TO-263-3-2 (D²-PAK)

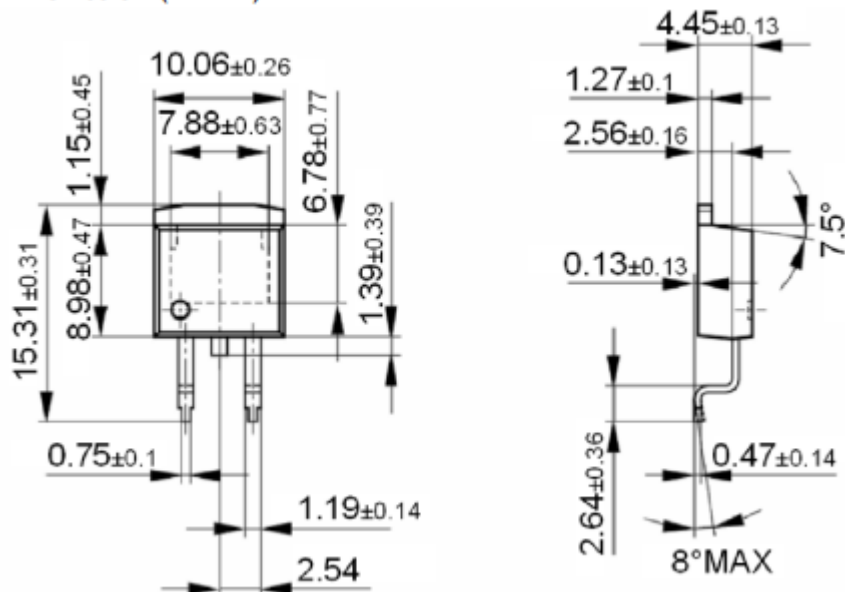

P-TO-220-3-31 (FullPAK)

